



2021 PRODUCT GUIDE



KALEA BAY



Kalea Bay Outdoor Linear Gas Fireplace



Make a modern statement with the all-new Kalea Bay LED & Non-LED outdoor linear gas fireplace. Designed with a clean and contemporary style in mind. No chimney or venting required makes it an ideal product for quick & efficient framing & finishing.

Features

- LED Models: Full spectrum lighting - Requires 120VAC power.
- Non-LED Models: Battery-operated Ignition.
- Four Sizes 36" / 48" / 60" / 72" (all 16" tall opening).
- Burner & firebox constructed of weather/corrosion resistant 304 stainless steel.
- Ecoflow Electronic Ignition System features built-in safety shutoff in case of loss of flame and auto-relight.
- Control Center with each model housed in 304 Stainless Steel Cabinet.
- Ships as Natural Gas (NG) or Liquid Propane (LP). Field Convertible to Liquid Propane (LP). Conversion Kits sold separately.
- Tested & Approved to: ANSI Z21.97-2014/CSA 2.41-2014 standards.



LED Models



Controls: On / Off, Low / High, Continuous Pilot, Learn & LED On/Off.



Use the RGB dials to get your desired color, there are over 16 million to choose from!

NON-LED Models



Controls: On / Off, Low / High, Continuous Pilot, & Learn.



C Batteries (4)

Easy access to the battery tray makes maintenance for the Kalea Bay a breeze.



Kalea Bay | LED Models



Model No.	Size	BTU High	Weather Cover	LP Conversion
OFP-36LECO-*LED	36"	31,000	OFP-36COV	OFP-36LECO-LPK
OFP-48LECO-*LED	48"	43,500	OFP-48COV	OFP-48LECO-LPK
OFP-60LECO-*LED	60"	50,000	OFP-60COV	OFP-60LECO-LPK
OFP-72LECO-*LED	72"	65,000	OFP-72COV	OFP-72LECO-LPK

* You must select your gas type. N = Natural Gas. P = Liquid Propane

Kalea Bay | NON-LED Models



Model No.	Size	BTU High	Weather Cover	LP Conversion
OFP-36LECO-*	36"	31,000	OFP-36COV	OFP-36LECO-LPK
OFP-48LECO-*	48"	43,500	OFP-48COV	OFP-48LECO-LPK
OFP-60LECO-*	60"	50,000	OFP-60COV	OFP-60LECO-LPK
OFP-72LECO-*	72"	65,000	OFP-72COV	OFP-72LECO-LPK

* You must select your gas type. N = Natural Gas. P = Liquid Propane

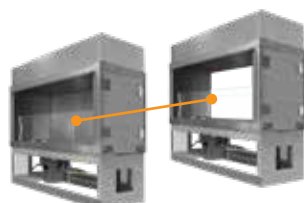

See-Through Conversion Kits

The Kalea Bay ships single sided, but you can convert to See-Through!



Weather Cover

Our covers are made of 304 Stainless Steel and are available for each size.

Model No.	Fits Model
78002	OFP-36LECO-NLED (36" LED Kalea Bay)
78004	OFP-48LECO-NLED (48" LED Kalea Bay)
78006	OFP-60LECO-NLED (60" LED Kalea Bay)
78008	OFP-72LECO-NLED (72" LED Kalea Bay)
78009	OFP-36LECO-N (36" NON-LED Kalea Bay)
78010	OFP-48LECO-N (48" NON-LED Kalea Bay)
78011	OFP-60LECO-N (60" NON-LED Kalea Bay)
78012	OFP-72LECO-N (72" NON-LED Kalea Bay)

Model No.	Description
OFP-36COV	36" Kalea Bay weather cover
OFP-48COV	48" Kalea Bay weather cover
OFP-60COV	60" Kalea Bay weather cover
OFP-72COV	72" Kalea Bay weather cover

Installation Accessories

Model No.	Description
77111	10' long, 6-pin LED extension wire harness (for LED models only)
77161	10' long, weatherproof extension wire harness (for Kalea Bay fireplaces - replaces 77116)
VCS-ECOBBUEXT120-2	2-Pin battery pack extension wire for the battery pack on the NON-LED Kalea Bay



SANCTUARY SERIES



Ignition Systems Sanctuary Series



AWS Systems

All Weather Electronic System

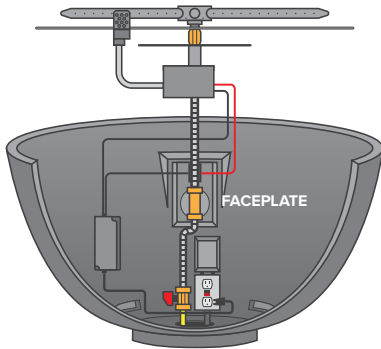

Our top of the line fully electronic ignition system. Ships with a GEO-30VDC power supply and an on/off toggle switch.



AWS Faceplate

TMSI Systems

Thermocouple Manual Safety (Spark Ignition)

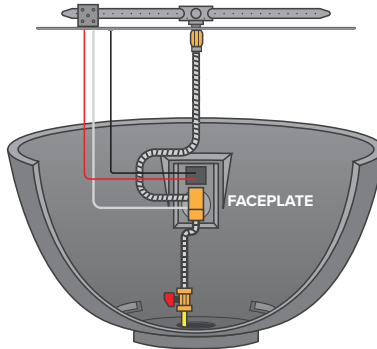

Battery operated manual spark ignition system using a variable flame control knob. Safety valve turns gas off in case of flame loss.



TMSI Faceplate

MT Systems

Match Throw

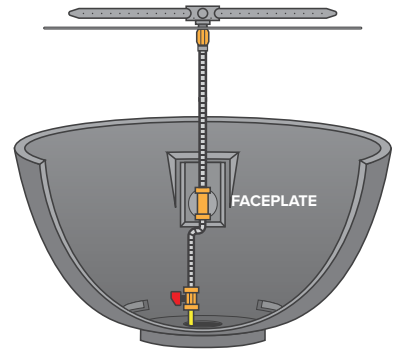

Easy lighting with a butane lighter or match. Variable flame height adjustment using a key valve.



MT Faceplate

Weather Cover



Protect your fire feature with our heavy-duty PVC covers, 100 percent water-resistant, UV-Protected to prevent fading, custom fitted, and feature soft flannel backing (to keep your fire feature scratch free).

Propane Tank Holder



Holds one (1) 20 lb. tank. Easy to remove top. Weight: 159 lb. Dimensions: 20" W x 21 1/2" H



Sanctuary 1

The Sanctuary 1 comes in 5 different colors (listed below). The weather cover is included. LP Conversion Kits are sold separately.

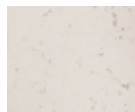

Arctic
AR



Cream
CR



Mocha
MO



Raven
RA



Slate
SL

Model No.	Ignition	Table Size	BTU NG	Weather Cover	LP Conversion
SAN1-30LHAWS-* XX	AWS	56" W x 16" H x 38" D	65,000	COVER-SAN1	OAS-LPK41 + FG-AWS-PBO-P
SAN1-30LHTMSI-N- XX	TMSI	56" W x 16" H x 38" D	65,000	COVER-SAN1	OAS-LPK41

XX: You must select your color. Refer to colors above the table.

* You must select your gas type. N = Natural Gas. P = Liquid Propane

Sanctuary 2

The Sanctuary 2 comes in 5 different colors (listed below). The weather cover is included. LP Conversion Kits are sold separately.

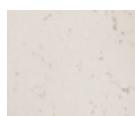

Arctic
AR



Cream
CR



Mocha
MO



Raven
RA



Slate
SL

Model No.	Ignition	Bowl Size	BTU NG	Weather Cover	LP Conversion
SAN2-34DBSAWS-* XX	AWS	39" Diameter x 18" H	65,000	COVER-SAN2	OAS-LPK41 + FG-AWS-PBO-P
SAN2-34DBSTMSI-N- XX	TMSI	39" Diameter x 18" H	65,000	COVER-SAN2	OAS-LPK41
SAN2-34DBSMT-* XX	MT	39" Diameter x 18" H	75,000	COVER-SAN2	OAS-LPK41

XX: You must select your color. Refer to colors above the table.

* You must select your gas type. N = Natural Gas. P = Liquid Propane

Sanctuary 3

The Sanctuary 3 comes in 5 different colors (listed below). The weather cover is included. LP Conversion Kits are sold separately.

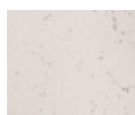

Arctic
AR



Cream
CR



Mocha
MO



Raven
RA



Slate
SL

Model No.	Ignition	Bowl Size	BTU NG	Weather Cover	LP Conversion
SAN3-26DBSAWS-* XX	AWS	30" Diameter x 14 1/4" H	65,000	COVER-SAN3	OAS-LPK41 + FG-AWS-PBO-P
SAN3-26DBSTMSI-N- XX	TMSI	30" Diameter x 14 1/4" H	65,000	COVER-SAN3	OAS-LPK41
SAN3-26DBSMT-* XX	MT	30" Diameter x 14 1/4" H	75,000	COVER-SAN3	OAS-LPK41

XX: You must select your color. Refer to colors above the table.

* You must select your gas type. N = Natural Gas. P = Liquid Propane



IGNITION SYSTEMS

AWS All Weather Electronic Ignition System



Single Fire Feature



Weather Resistant

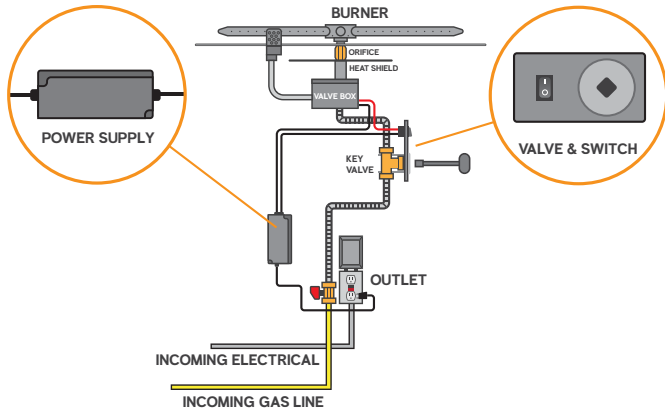

How it Lights

If you chose an FPB or LOF system (see page 8 & 10), the system lights by pressing the toggle switch on the faceplate.

OR

Multiple Fire Features



Multiple Fire Features



Pool Certified



Weather Resistant

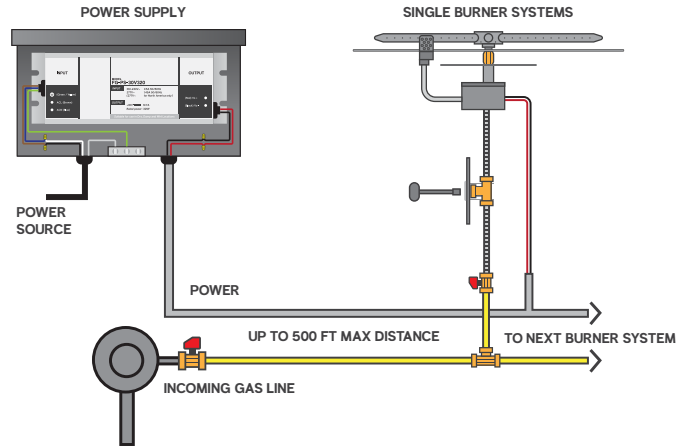

How it Lights

If you choose our A La Carte System, the way to operate your fire features are endless! See page 7 to learn more about the A La Carte Purchasing System!

TMSI Thermocouple Manual Safety with Spark Ignition

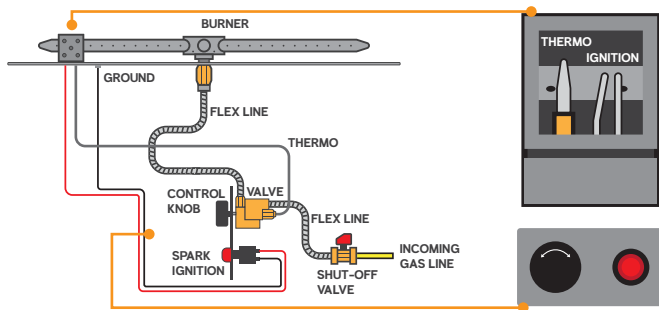

Overview

- Thermocouple Manual Safety TMS Technology (Non-Piloted, Non-Filament Systems)
- Manual Spark Ignitor Kit included
- TMS System with Safety Valve turns gas off when flame goes out
- Robust ignition system with full BTU throughput

How it Lights

Turn the control knob to the ON position. Press the Spark Ignition button. Press the control knob inward while pressing the spark ignition. After the fire lights, continue to hold the control knob for 30 seconds. To turn off the fire pit, depress the control knob slightly and turn to the OFF position.

MT Match Throw

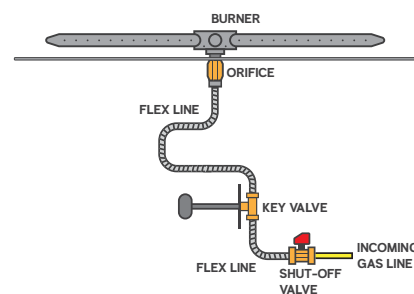

Overview

- Most popular ignition system, least amount of cost
- Light a match or a butane lighter
- Can be used in residential installs
- This system is the easiest to use, and with non-listed burners you can achieve high BTU's and big flames.

How it Lights

Insert key into shut-off valve. Light a butane lighter or match. Hold it near the burner and turn gas on. The gas will ignite. To turn off, insert the key valve and turn to OFF position.



AWS A La Carte Purchase System

Single Fire Feature



- Used for a single fire feature.
- Can only be installed in fire features that are greater than 10 feet away from a pool or spa.
- All components can be housed underneath the burner.

KIT: FG-AWS30VDC-GOEK-*

** You must select your gas type
N = Natural Gas. P = Liquid Propane*



Valve, Pilot, and Heat Shield



Key Valve and Switch



Power Supply



Hardware Bag

or

Multiple Fire Features

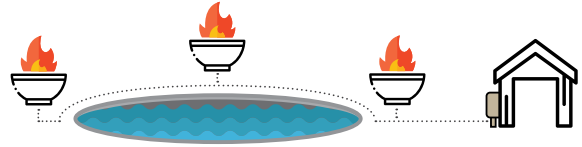

- Used when running 1 – 4 fire features. Also used when running a single or multiple fire features within 5 feet of a pool / spa.
- One kit per fire feature. One power supply (sold separately) for every 4 fire features.

KIT: FG-AWS30VDC-K-*

** You must select your gas type
N = Natural Gas. P = Liquid Propane*



Valve, Pilot, and Heat Shield



Hardware Bag

+

Power Supply
FG-AWS-PS-30V320



Ignition & Accessories



FG-EMER-STOP

Electrical Emergency Stop for 120VAC or 30VDC Appliances, housed in Weatherproof J-Box and Weatherproof Cover



FG-TIMER-2HR

120VAC Two (2) Hour Mechanical Timer, housed in Weatherproof J-Box and Weatherproof Cover



FG-WS-OD

120VAC Wired Wall Switch housed in Weatherproof J-Box and Weatherproof Cover



FG-1420-AOD

1420-A (On/Off/Remote) with 110 Receiver. With weatherproof J-Box and weatherproof cover



PRO SERIES BURNER SYSTEMS

Pro Series AWS Burner Systems

* You must select your gas type. N = Natural Gas. P = Liquid Propane

Round Drop-In

AWS



Model No.	Pan	BTU (NG)
FPB-19RPSBR14AWS-*	19"	100,000
FPB-25RPSBR21AWS-*	25"	140,000
FPB-29RPSBR21AWS-*	29"	140,000
FPB-33RPSBR21AWS-*	33"	140,000

Square Drop-In

AWS



Model No.	Pan	BTU (NG)
FPB-20SPSBR14AWS-*	20"	100,000
FPB-26SPSBR21AWS-*	26"	140,000
FPB-32SPSBR21AWS-*	32"	140,000

Round Flat

AWS



Model No.	Pan Size	BTU (NG)
FPB-26DPSBR21AWS-*	26"	140,000
FPB-29DPSBR21AWS-*	29"	140,000
FPB-34DPSBR21AWS-*	34"	140,000

Square Flat

AWS



Model No.	Pan Size	BTU (NG)
FPB-25SFPSBR21AWS-*	25"	140,000
FPB-30SFPSBR21AWS-*	30"	140,000
FPB-34SFPSBR21AWS-*	34"	140,000

Line of Fire - H Flat

AWS



Model No.	Pan Size	BTU (NG)
LOF-3010PS246AWS-*	30" x 10"	120,000
LOF-3610PS306AWS-*	36" x 10"	150,000
LOF-4810PS406AWS-*	48" x 10"	200,000
LOF-6010PS506AWS-*	60" x 10"	270,000
LOF-7210PS606AWS-*	72" x 10"	280,000
LOF-9610PS806AWS-*	96" x 10"	290,000



Pro Series MT Burner Systems

* You must select your gas type. N = Natural Gas. P = Liquid Propane

Round Drop-In

MT



Model No.	Pan	BTU (NG)
FPB-19RPSBR14MT-*	19"	100,000
FPB-25RPSBR21MT-*	25"	140,000
FPB-29RPSBR21MT-*	29"	140,000
FPB-33RPSBR21MT-*	33"	140,000

Square Drop-In

MT



Model No.	Pan	BTU (NG)
FPB-20SPSBR14MT-*	20"	100,000
FPB-26SPSBR21MT-*	26"	140,000
FPB-32SPSBR21MT-*	32"	140,000

Round Flat

MT



Model No.	Pan Size	BTU (NG)
FPB-26DPSBR21MT-*	26"	140,000
FPB-29DPSBR21MT-*	29"	140,000
FPB-34DPSBR21MT-*	34"	140,000

Square Flat

MT



Model No.	Pan Size	BTU (NG)
FPB-25SFPSBR21MT-*	25"	140,000
FPB-30SFPSBR21MT-*	30"	140,000
FPB-34SFPSBR21MT-*	34"	140,000

Line of Fire - H Flat

MT



Model No.	Pan Size	BTU (NG)
LOF-3010PS246MT-*	30" x 10"	120,000
LOF-3610PS306MT-*	36" x 10"	150,000
LOF-4810PS406MT-*	48" x 10"	200,000
LOF-6010PS506MT-*	60" x 10"	280,000
LOF-7210PS606MT-*	72" x 10"	290,000
LOF-9610PS806MT-*	96" x 10"	300,000



BURNER SYSTEMS

All Burner Systems are fully assembled at the factory.

Stainless Steel AWS Burner Systems

* You must select your gas type. N = Natural Gas. P = Liquid Propane



Round Drop-In

AWS



Model No.	Pan	BTU (NG)
FPB-29RBSAWS-*	29"	125,000
FPB-33RBSAWS-*	33"	175,000

Square Drop-In

AWS



Model No.	Pan	BTU (NG)
FPB-20SBSAWS-*	20"	75,000
FPB-26SBSAWS-*	26"	125,000
FPB-32SBSAWS-*	32"	175,000
FPB-38SBSAWS-*	38"	250,000

Round Flat

AWS



Model No.	Pan	BTU (NG)
FPB-26DBSAWS-*	26"	125,000
FPB-29DBSAWS-*	29"	125,000
FPB-34DBSAWS-*	34"	175,000
FPB-39DBSAWS-*	39"	250,000
FPB-44DBSAWS-*	44"	250,000

Square Flat

AWS



Model No.	Pan	BTU (NG)
FPB-25SFBSAWS-*	25"	125,000
FPB-30SFBSAWS-*	30"	125,000
FPB-34SFBSAWS-*	34"	175,000
FPB-40SFBSAWS-*	40"	250,000
FPB-46SFBSAWS-*	46"	250,000

Line of Fire - H Drop-In

AWS



Model No.	Pan	BTU (NG)
LOF-2412HAWS-*	24" x 12"	50,000
LOF-3012HAWS-*	30" x 12"	100,000
LOF-3614HAWS-*	36" x 14"	125,000
LOF-4814HAWS-*	48" x 14"	150,000
LOF-6016HAWS-*	60" x 16"	175,000
LOF-7216HAWS-*	72" x 16"	200,000
LOF-8416HAWS-*	84" x 16"	225,000
LOF-9616HAWS-*	96" x 16"	250,000

Line of Fire - H Flat

AWS



Model No.	Pan	BTU (NG)
LOF-2414FHAWS-*	24" x 14"	50,000
LOF-3014FHAWS-*	30" x 14"	100,000
LOF-3614FHAWS-*	36" x 14"	125,000
LOF-4814FHAWS-*	48" x 14"	150,000
LOF-6016FHAWS-*	60" x 16"	175,000
LOF-7216FHAWS-*	72" x 16"	200,000
LOF-8416FHAWS-*	84" x 16"	225,000
LOF-9616FHAWS-*	96" x 16"	250,000



Line of Fire - T Drop-In **AWS**



Model No.	Pan	BTU (NG)
LOF-2406TAWS-*	24" x 6"	50,000
LOF-3006TAWS-*	30" x 6"	50,000
LOF-3606TAWS-*	36" x 6"	75,000
LOF-4806TAWS-*	48" x 6"	100,000
LOF-6006TAWS-*	60" x 6"	125,000
LOF-7206TAWS-*	72" x 6"	150,000
LOF-8406TAWS-*	84" x 6"	175,000
LOF-9606TAWS-*	96" x 6"	200,000

Line of Fire - T Flat **AWS**



Model No.	Pan	BTU (NG)
LOF-2408FTAWS-*	24" x 8"	50,000
LOF-3008FTAWS-*	30" x 8"	50,000
LOF-3608FTAWS-*	36" x 8"	75,000
LOF-4808FTAWS-*	48" x 8"	100,000
LOF-6008FTAWS-*	60" x 8"	125,000
LOF-7208FTAWS-*	72" x 8"	150,000
LOF-8408FTAWS-*	84" x 8"	175,000
LOF-9608FTAWS-*	96" x 8"	200,000

Stainless Steel TMSI Burner Systems

TMSI units ship as Natural Gas. See page 13 for LP Conversion Kits

Round Drop-In **TMSI**



Model No.	Pan	BTU (NG)
FPB-19RBSTMSI-N	19"	65,000
FPB-25RBSTMSI-N	25"	65,000
FPB-33RBSTMSI-N	33"	65,000

Square Drop-In **TMSI**



Model No.	Pan	BTU (NG)
FPB-20SBSTMSI-N	20"	65,000
FPB-26SBSTMSI-N	26"	65,000



Round Flat **TMSI**



Model No.	Pan	BTU (NG)
FPB-26DBSTMSI-N	26"	65,000
FPB-29DBSTMSI-N	29"	65,000
FPB-34DBSTMSI-N	34"	65,000

Square Flat **TMSI**



Model No.	Pan	BTU (NG)
FPB-25SFBSTMSI-N	25"	65,000
FPB-30SFBSTMSI-N	30"	65,000



BURNER SYSTEMS

All Burner Systems are fully assembled at the factory.

Stainless Steel MT Burner Systems

MT units ship as Natural Gas. See page 13 for LP Conversion Kits

Round Drop-In

MT



Model No.	Pan	BTU (NG)
FPB-16RBSMT-N	16"	50,000
FPB-19RBSMT-N	19"	75,000
FPB-25RBS22MT-N	25"	125,000
FPB-29RBS22MT-N	29"	125,000
FPB-33RBS31MT-N	33"	175,000

Square Drop-In

MT



Model No.	Pan	BTU (NG)
FPB-20SBSMT-N	20"	75,000
FPB-26SBS22MT-N	26"	125,000
FPB-32SBS31MT-N	32"	175,000
FPB-38SBS36MT-N	38"	250,000



Round Flat

MT



Model No.	Pan	BTU (NG)
FPB-26DBS22MT-N	26"	125,000
FPB-29DBS22MT-N	29"	125,000
FPB-34DBS31MT-N	34"	175,000
FPB-39DBS36MT-N	39"	250,000
FPB-44DBS36MT-N	44"	250,000

Square Flat

MT



Model No.	Pan	BTU (NG)
FPB-25SFBS22MT-N	25"	125,000
FPB-30SFBS22MT-N	30"	125,000
FPB-34SFBS31MT-N	34"	175,000
FPB-40SFBS36MT-N	40"	250,000
FPB-46SFBS36MT-N	46"	250,000

Line of Fire - H Drop-In

MT



Model No.	Pan	BTU (NG)
LOF-2412HMT-N	24" x 12"	75,000
LOF-3012HMT-N	30" x 12"	100,000
LOF-3614HMT-N	36" x 14"	125,000
LOF-4214HMT-N	42" x 14"	125,000
LOF-4814HMT-N	48" x 14"	150,000
LOF-6016HMT-N	60" x 16"	175,000
LOF-7216HMT-N	72" x 16"	200,000
LOF-8416HMT-N	84" x 16"	225,000
LOF-9616HMT-N	96" x 16"	250,000

Line of Fire - H Flat

MT



Model No.	Pan	BTU (NG)
LOF-2414FHMT-N	24" x 14"	75,000
LOF-3014FHMT-N	30" x 14"	100,000
LOF-3614FHMT-N	36" x 14"	125,000
LOF-4814FHMT-N	48" x 14"	150,000
LOF-6016FHMT-N	60" x 16"	175,000
LOF-7216FHMT-N	72" x 16"	200,000
LOF-8416FHMT-N	84" x 16"	225,000
LOF-9616FHMT-N	96" x 16"	250,000



Line of Fire - T Drop-In MT



Model No.	Pan	BTU (NG)
LOF-2406TMT-N	24" x 6"	50,000
LOF-3006TMT-N	30" x 6"	50,000
LOF-3606TMT-N	36" x 6"	75,000
LOF-4806TMT-N	48" x 6"	100,000
LOF-6006TMT-N	60" x 6"	125,000
LOF-7206TMT-N	72" x 6"	150,000
LOF-8406TMT-N	84" x 6"	175,000
LOF-9606TMT-N	96" x 6"	200,000

Line of Fire - T Flat MT



Model No.	Pan	BTU (NG)
LOF-2408FTMT-N	24" x 8"	50,000
LOF-3008FTMT-N	30" x 8"	50,000
LOF-3608FTMT-N	36" x 8"	75,000
LOF-4808FTMT-N	48" x 8"	100,000
LOF-6008FTMT-N	60" x 8"	125,000
LOF-7208FTMT-N	72" x 8"	150,000
LOF-8408FTMT-N	84" x 8"	175,000
LOF-9608FTMT-N	96" x 8"	200,000

Propane Conversion Kits for Stainless Steel FPB Burner Systems

Model No.	Model matches	Contains
OAS-LPK12	Universal LP Conversion kit for: 250,000 BTU	OAS-LP12, #S499-8, #113-SS4-D5, U3-8D-S
OAS-LPK19	Universal LP Conversion kit for: 225,000 BTU	OAS-LP19, #S499-8, #113-SS4-D5, U3-8D-S
OAS-LPK22	Universal LP Conversion kit for: 200,000 BTU	OAS-LP22, #S499-8, #113-SS4-D5, U3-8D-S
OAS-LPK26	Universal LP Conversion kit for: 175,000 BTU	OAS-LP26, #S499-8, #113-SS4-D5, U3-8D-S
OAS-LPK29	Universal LP Conversion kit for: 150,000 BTU	OAS-LP29, #S499-8, #113-SS4-D5, U3-8D-S
OAS-LPK31	Universal LP Conversion kit for: 125,000 BTU	OAS-LP31, #S499-8, #113-SS4-D5, U3-8D-S
OAS-LPK35	Universal LP Conversion kit for: 100,000 BTU	OAS-LP35, #S499-8, #113-SS4-D5, U3-8D-S
OAS-LPK41	Universal LP Conversion kit for: 75,000 BTU	OAS-LP41, #S499-8, #113-SS4-D5, U3-8D-S
OAS-LPK47	Universal LP Conversion kit for: 50,000 BTU	OAS-LP47, #S499-8, #113-SS4-D5, U3-8D-S



BURNER KITS

Pro Brass Burner Kits

* You must select your gas type. N = Natural Gas. P = Liquid Propane

Burning Spur Kits

PRO SERIES



Model No.	Size	BTU (NG)
FG-PSBR-BS10-*K	10"	65,000
FG-PSBR-BS14-*K	14"	100,000
FG-PSBR-BS21-*K	21"	140,000

Burning Spurs

PRO SERIES



Model No.	Size	BTU (NG)
FG-PSBR-BS10-*	10"	65,000
FG-PSBR-BS14-*	14"	100,000
FG-PSBR-BS21-*	21"	140,000

H Burner Kits

PRO SERIES

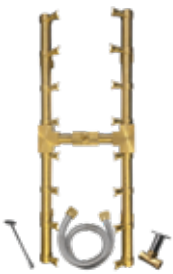

Model No.	Size	BTU (NG)
FG-PSBR-H24-*K	24" x 6.75"	120,000
FG-PSBR-H30-*K	30" x 6.75"	150,000
FG-PSBR-H40-*K	40" x 6.75"	200,000
FG-PSBR-H50-*K	50" x 6.75"	280,000
FG-PSBR-H60-*K	60" x 6.75"	300,000
FG-PSBR-H80-*K	80" x 6.75"	300,000

H Burners

PRO SERIES



Model No.	Size	BTU (NG)
FG-PSBR-H24-*	24" x 6.75"	120,000
FG-PSBR-H30-*	30" x 6.75"	150,000
FG-PSBR-H40-*	40" x 6.75"	200,000
FG-PSBR-H50-*	50" x 6.75"	280,000
FG-PSBR-H60-*	60" x 6.75"	300,000
FG-PSBR-H80-*	80" x 6.75"	300,000

T Burner Kits

PRO SERIES



Model No.	Size	BTU (NG)
FG-PSBR-T24-*K	24"	60,000
FG-PSBR-T34-*K	34"	85,000
FG-PSBR-T42-*K	42"	105,000
FG-PSBR-T56-*K	56"	140,000
FG-PSBR-T68-*K	68"	170,000
FG-PSBR-T88-*K	88"	220,000
FG-PSBR-T98-*K	98"	245,000
FG-PSBR-T110-*K	110"	275,000
FG-PSBR-T122-*K	122"	305,000

T Burners

PRO SERIES



Model No.	Size	BTU (NG)
FG-PSBR-T24-*	24"	60,000
FG-PSBR-T34-*	34"	85,000
FG-PSBR-T42-*	42"	105,000
FG-PSBR-T56-*	56"	140,000
FG-PSBR-T68-*	68"	170,000
FG-PSBR-T88-*	88"	220,000
FG-PSBR-T98-*	98"	245,000
FG-PSBR-T110-*	110"	275,000
FG-PSBR-T122-*	122"	305,000

Stainless Steel Burner Kits

All Stainless Steel kits ship as Natural Gas. See page 13 for LP Conversion Kits

Fire Ring Kits

STAINLESS STEEL



Model No.	Size	BTU (NG)
FG-FR-6SSK	6"	50,000
FG-FR-12SSK	12"	50,000
FG-FR-18SSK	18"	75,000
FG-FR-24SSK	24"	125,000
FG-FR-30SSK	30"	250,000
FG-FR-36SSK	36"	350,000
FG-FR-48SSK	48"	350,000

Fire Rings

STAINLESS STEEL



Model No.	Size	BTU (NG)
FG-FR-6SS	6"	50,000
FG-FR-12SS	12"	50,000
FG-FR-18SS	18"	75,000
FG-FR-24SS	24"	125,000
FG-FR-30SS	30"	250,000
FG-FR-36SS	36"	350,000
FG-FR-48SS	48"	350,000



PRO BURNERS



STAINLESS BURNERS

Burning Spur Kits MADE IN USA



STAINLESS STEEL

Model No.	Size	BTU (NG)
DBS-12K	12"	50,000
DBS-16K	16"	75,000
DBS-22K	22"	125,000
DBS-31K	31"	175,000
DBS-36K	36"	250,000

Burning Spurs MADE IN USA



STAINLESS STEEL

Model No.	Size	BTU (NG)
DBS-12	12"	50,000
DBS-16	16"	75,000
DBS-22	22"	125,000
DBS-31	31"	175,000
DBS-36	36"	250,000

H Burner Kits MADE IN USA



STAINLESS STEEL

Model No.	Size	BTU (NG)
FG-H-2406SSK	24" x 6"	75,000
FG-H-3006SSK	30" x 6"	100,000
FG-H-3606SSK	36" x 6"	125,000
FG-H-4806SSK	48" x 6"	175,000

H Burners MADE IN USA



STAINLESS STEEL

Model No.	Size	BTU (NG)
FG-H-2406SS	24" x 6"	75,000
FG-H-3006SS	30" x 6"	100,000
FG-H-3606SS	36" x 6"	125,000
FG-H-4806SS	48" x 6"	175,000



Model No.	Size	BTU (NG)
FG-H-2110SSK	21" x 10"	75,000
FG-H-2710SSK	27" x 10"	100,000
FG-H-3310SSK	33" x 10"	125,000
FG-H-4510SSK	45" x 10"	150,000
FG-H-5710SSK	57" x 10"	175,000
FG-H-6910SSK	69" x 10"	200,000
FG-H-8110SSK	81" x 10"	225,000
FG-H-9310SSK	93" x 10"	250,000



Model No.	Size	BTU (NG)
FG-H-2110SS	21" x 10"	75,000
FG-H-2710SS	27" x 10"	100,000
FG-H-3310SS	33" x 10"	125,000
FG-H-4510SS	45" x 10"	150,000
FG-H-5710SS	57" x 10"	175,000
FG-H-6910SS	69" x 10"	200,000
FG-H-8110SS	81" x 10"	225,000
FG-H-9310SS	93" x 10"	250,000

T Burner Kits MADE IN USA



STAINLESS STEEL

Model No.	Size	BTU (NG)
FG-T-21SSK	21"	50,000
FG-T-27SSK	27"	50,000
FG-T-33SSK	33"	75,000
FG-T-45SSK	45"	100,000
FG-T-57SSK	57"	125,000
FG-T-69SSK	69"	150,000
FG-T-81SSK	81"	175,000
FG-T-93SSK	93"	200,000

T Burners MADE IN USA



STAINLESS STEEL





























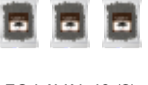



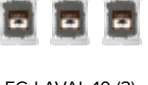

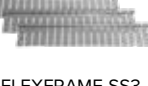

















Model No.	Size	BTU (NG)
FG-T-21SS	21"	50,000
FG-T-27SS	27"	50,000
FG-T-33SS	33"	75,000
FG-T-45SS	45"	100,000
FG-T-57SS	57"	125,000
FG-T-69SS	69"	150,000
FG-T-81SS	81"	175,000
FG-T-93SS	93"	200,000



SRW/PAVER FPB PACKAGES & ACCESSORIES

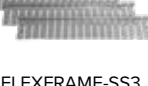

SRW / Paver FPB Packages

FPB-29DTMSIN-PK	PACKAGE CONTAINS		+		+		+		+	
		FPB-29DBSTMSI-N		FLEXFRAME-SS		PAVER-VENT-4LNLS		PAVER-CP-TMSI		FG-LAVAL-10 (3)
FPB-34DTMSIN-PK	PACKAGE CONTAINS		+		+		+		+	
		FPB-34DBSTMSI-N		FLEXFRAME-SS3		PAVER-VENT-4LNLS		PAVER-CP-TMSI		FG-LAVAL-40
FPB-30SFTMSIN-PK	PACKAGE CONTAINS		+		+		+		+	
		FPB-30SFBSTMSI-N		FLEXFRAME-SS3		PAVER-VENT-4LNLS		PAVER-CP-TMSI		FG-LAVAL-10 (3)
FPB-29D22MTN-PK	PACKAGE CONTAINS		+		+		+		+	
		FPB-29DBS22MT-N		FLEXFRAME-SS		PAVER-VENT-4LNLS		PAVER-CP-MT		FG-LAVAL-10 (3)
FPB-34D31MTN-PK	PACKAGE CONTAINS		+		+		+		+	
		FPB-34DBS31MT-N		FLEXFRAME-SS3		PAVER-VENT-4LNLS		PAVER-CP-MT		FG-LAVAL-10 (3)
FPB-34D31MTN-PK2	PACKAGE CONTAINS		+		+		+		+	
		FPB-34DBS31MT-N		FLEXFRAME-SS3		PAVER-VENT-6LNLS		PAVER-CP-MT		FG-LAVAL-40
FPB-44DBS36MTN-PK	PACKAGE CONTAINS		+		+		+		+	
		FPB-44DBS36MT-N		FLEXFRAME-SS3		PAVER-VENT-4LNLS		PAVER-CP-MT		FG-LAVAL-40 + 10
FPB-25SF22MTN-PK	PACKAGE CONTAINS		+		+		+		+	
		FPB-25SFB22MT-N		FLEXFRAME-SS3		PAVER-VENT-4LNLS		PAVER-CP-MT		FG-LAVAL-10 (3)
FPB-30SF22MTN-PK	PACKAGE CONTAINS		+		+		+		+	
		FPB-30SFB22MT-N		FLEXFRAME-SS3		PAVER-VENT-4LNLS		PAVER-CP-MT		FG-LAVAL-10 (3)
FPB-34SF31MTN-PK	PACKAGE CONTAINS		+		+		+		+	
		FPB-34SFB31MT-N		FLEXFRAME-SS3		PAVER-VENT-4LNLS		PAVER-CP-MT		FG-LAVAL-40
FPB-40SFS36MTN-PK	PACKAGE CONTAINS		+		+		+		+	
		FPB-40SFB36MT-N		FLEXFRAME-SS3		PAVER-VENT-4LNLS		PAVER-CP-MT		FG-LAVAL-40



SRW PACKAGES



FLEXFRAME



CONTROL PANELS



VENT KITS

Flexframe

Allows you the flexibility to fill the gap between the fire pit structure and the pan.

Allows you to easily remove the burner without disturbing the structure.

Flexible and easy to adapt for round, square, and rectangular fire pits.

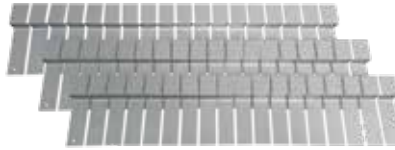

FLEXFRAME-PRO3

Wider version of the flexframe. Comes as a three piece kit. This larger size allows the use of any round, square or linear drop-in pan or flat in fire pits up to 5" larger than their OD size.

Three (3) 44" pieces per package.

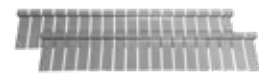

FLEXFRAME-SS

Two (2) 44" pieces per package.

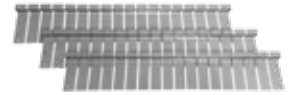

FLEXFRAME-SS3

Three (3) 44" pieces per package.



SRW / Paver Control Panels



PAVER-CP-AWS

For use when building fire pit enclosures with SRW block and an AWS burner system.

INCLUDES:

SRW bracket kit and extender
Lintel - 12" L x 3" W
Screws and fittings
Tapcon® concrete anchors



PAVER-CP-TMSI

For use when building fire pit enclosures with SRW block and an TMSI burner system.

INCLUDES:

SRW bracket kit and extender
Lintel - 12" L x 3" W
Screws and fittings
Tapcon® concrete anchors



PAVER-CP-MT-MSI

For use when building fire pit enclosures with SRW block and an MT burner system.

INCLUDES:

Face plate for key valve and MSI
SRW bracket kit and extender
Lintel - 12" L x 3" W
Battery operated Piezo igniter
Ignition hood
Screws and fittings
Tapcon® concrete anchors



PAVER-CP-MT

For use when building fire pit enclosures with SRW block and an MT burner system.

INCLUDES:

SRW bracket kit and extender
Lintel - 12" L x 3" W
Screws and fittings
Tapcon® concrete anchors



SRW / Paver Vent Kits



PAVER-VENT-4-LNTS

Stainless steel SRW vent kit with lintel.

INCLUDES:

Two (2) 3 5/8"H x 8"W vents with mounting plate, extension plate extends overall size up to 10"W
Two (2) Tapcon® concrete anchors
Two (2) Lintels 12"L x 3"W (20 gauge galvanized steel)
Each vent provides 18 square inches of ventilation



PAVER-VENT-6-LNTS

Stainless steel SRW vent kit with lintel.

INCLUDES:

Two (2) 5 5/8"H x 8"W vents with mounting plate, extension plate extends overall size up to 10"W
Two (2) Tapcon® concrete anchors
Two (2) Lintels 12"L x 3"W (20 gauge galvanized steel)
Each vent provides 18 square inches of ventilation





READY TO FINISH ENCLOSURES



RTF

Ready to Finish (RTF)

Linear Enclosures



Ready to Finish (RTF)

Round Enclosures



Model No.	Dimensions
RTF-L4224	42" L x 24" W x 18" H
RTF-L4234	42" L x 34" W x 18" H
RTF-L6024	60" L x 24" W x 18" H
RTF-L6034	60" L x 34" W x 18" H
RTF-L8424	84" L x 24" W x 18" H
RTF-L8434	84" L x 34" W x 18" H
RTF-L10824	108" L x 24" W x 18" H
RTF-L10834	108" L x 34" W x 18" H

Model No.	Dimensions
RTF-R42	42" Diameter x 18" H
RTF-R48	48" Diameter x 18" H
RTF-R60	60" Diameter x 18" H

Ready to Finish (RTF)

Square Enclosures



Model No.	Dimensions
RTF-S42	42" W x 18" H
RTF-S48	48" W x 18" H
RTF-S60	60" W x 18" H



Media



Lava Rock

Each rock is approximately 1" to 2" in diameter

FG-LAVA-10 10 lbs.
FG-LAVA-40 1 cubic foot
Approx 30 - 40 lbs.



Lava Stones

Each stone is approximately 1" to 2" in diameter

FG-LS50 50 lbs.

Glass

Broken Glass

Approximately 1/2" to 3/4" in size.



Black
GL-BLACK-10



Copper
GL-COPPER-10



Crystal
GL-CRYSTAL-10



Light Blue
GL-LIGHTBLUE-10



Seabreeze
GL-SEABREEZE-10

Sold in 10lb jugs



Reflective Glass

Approximately 1/2" to 3/4" in size.



Black
GRL-BLACK-10



Bronze
GRL-BRONZE-10

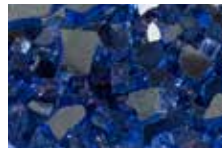

Cobalt
GRL-COBALT-10



Copper
GRL-COPPER-10



Silver
GRL-SILVER-10



Tahiti
GRL-TAHITI-10

Sold in 10lb jugs

Pro Series Steel Log Sets



Ironwood Steel (7)
L-IW-SM



Ironwood Steel (11)
L-IW-MED



Ironwood Steel (14)
L-IW-LG



Ironwood Steel (14)
L-IW-XL



Twig Set (4)
L-IW-TWIG810



Twig Set (5)
L-IW-TWIG1214

Pro Series Steel Twig Sets



Refractory Concrete Log Sets



Sedona (19)
L-SEDONA



Spit Fire (17)
L-SF



Birch (5)
L-BR-3048



Birch (6)
L-BR-6084



Driftwood (5)
L-DW-3048



Driftwood (6)
L-DW-6084



New Oak (5)
L-NO-3048



New Oak (6)
L-NO-6084

Refractory Concrete Twig Sets





ACCESSORIES



WINDSHIELDS



LIDS

Glass Windshields

All windshields are 1/4" thick (5mm)

Round Windshields



Model No.	Dimensions
GWS-23R	23" Diam. x 8" H
GWS-32R	32" Diam. x 8" H
GWS-36R	36" Diam. x 8" H
GWS-38R	38" Diam. x 8" H
GWS-48R	48" Diam. x 8" H
GWS-60R	60" Diam. x 8" H

Square Windshields



Model No.	Dimensions
GWS-2424	24" W x 7 1/2" H
GWS-3030	30" W x 7 1/2" H
GWS-3838	38" W x 7 1/2" H
GWS-4242	42" W x 7 1/2" H

Linear Windshields



Model No.	Dimensions
GWS-2911	29 1/2" L x 11 1/2" W x 6" H
GWS-2917	29" L x 17" W x 6" H
GWS-3511	35 1/2" L x 11 1/2" W x 6" H
GWS-3517	35" L x 17" W x 6" H
GWS-4111	41 1/2" L x 11 1/2" W x 6" H
GWS-4119	41" L x 19" W x 6" H
GWS-5311	53 1/2" L x 11 1/2" W x 6" H
GWS-5319	53" L x 19" W x 6" H
GWS-6511	65 1/2" L x 11 1/2" W x 6" H
GWS-6521	65" L x 21" W x 6" H
GWS-7711	77 1/2" L x 11 1/2" W x 6" H
GWS-7721	77" L x 21" W x 6" H

Lids

All lids are constructed of Stainless Steel



Round Lids



Model No.	Dimensions
LID-19R2	22" Diam. x 2 1/2" H
LID-25R2	28" Diam. x 2 1/2" H
LID-29R2	32" Diam. x 2 1/2" H
LID-33R2	36" Diam. x 2 1/2" H

* Height includes handle

Square Lids



Model No.	Dimensions
LID-20S	22 3/4" W x 2" H
LID-26S	28 3/4" W x 2" H
LID-32S	32 3/4" W x 2" H
LID-38S	38 3/4" W x 2" H

* Height includes handle

Linear Lids



Lids for LOF with "H" Burners

Model No.	Dimensions
LID-LOF2412	26 3/4" L x 14 3/4" W x 2 7/8" H
LID-LOF3012	32 3/4" L x 14 3/4" W x 2 7/8" H
LID-LOF3614	38 3/4" L x 16 3/4" W x 2 7/8" H
LID-LOF4214	44 3/4" L x 16 3/4" W x 2 7/8" H
LID-LOF4814	50 3/4" L x 16 3/4" W x 2 7/8" H
LID-LOF6016	62 3/4" L x 18 3/4" W x 2 7/8" H
LID-LOF7216	74 3/4" L x 18 3/4" W x 2 7/8" H
LID-LOF8416	86 3/4" L x 18 3/4" W x 2 7/8" H
LID-LOF9616	98 3/4" L x 18 3/4" W x 2 7/8" H

* Height includes handle



Lids for LOF with "T" Burners

Model No.	Dimensions
LID-LOF2406	26 3/4" L x 8 3/4" W x 2 7/8" H
LID-LOF3006	32 3/4" L x 8 3/4" W x 2 7/8" H
LID-LOF3606	38 3/4" L x 8 3/4" W x 2 7/8" H
LID-LOF4806	50 3/4" L x 8 3/4" W x 2 7/8" H
LID-LOF6006	62 3/4" L x 8 3/4" W x 2 7/8" H
LID-LOF7206	74 3/4" L x 8 3/4" W x 2 7/8" H
LID-LOF8406	86 3/4" L x 8 3/4" W x 2 7/8" H
LID-LOF9606	98 3/4" L x 8 3/4" W x 2 7/8" H

* Height includes handle



VALVE ACCESSORIES



ESTOP TIMER



LP ACCESSORIES

Gas Valves / Gas Valve Accessories / Vent Kit



KEY-PC-12
12" polished chrome key for key valve



KV-PC-12
High capacity straight key valve with polished chrome key cover and 12" key (350,000 BTU @ 1/2 PSI)



VENT-KIT-6X12SS
Includes 2 stainless steel 6" tall x 12" wide vents. Each vent provides 18 square inches of cross ventilation.



MSI-BSMTI
Manual spark ignition kit for FPB "MT" Match Throw Systems featuring the burning spur.

Estop Timers & Accessories



Unique all mechanical gas shut-off timer with built-in emergency stop - no power required
High Btu capacity
Safest gas timer available in the industry
Available in 2.5 and 1 hour models
Innovative multi-port design provides installation flexibility
1/2" NPT inlets and outlets (side and back)
Six (6) mounting holes (front and side) for secure installation
Natural gas (NG) or Liquid Propane (LP) - no conversion necessary
Dial has UV Protection



ESTOP1-0H
Mechanical timer with manual emergency shut-off. 1 hour countdown timer.



ESTOP2-5H
Mechanical timer with manual emergency shut-off. 2.5 hour countdown timer.



ESTOP-CP-KIT
Control panel designed to house ESTOP1-0H / ESTOP2-5H timers.



ESTOP-LC-KIT
Locking Cabinet designed to house ESTOP1-0H / ESTOP2-5H timers (Removable Lock)



ESTOP-RM-KIT
Surface mount enclosure designed to house ESTOP1-0H / ESTOP2-5H timers.

Propane Accessories



FG-12QDK
Quick Disconnect Kit for use with Natural Gas or Liquid Propane - 12' (144"), 3/8" I.D.



FG-32LPHRK
32" Liquid Propane Hose and Regulator Kit, Rated at 85,375 BTU @10" W.C. CSA-AGA/CGA Approved.



FG-60LPHRK
60" Liquid Propane Hose and Regulator Kit, Rated at 130K BTU @10" W.C. CSA-AGA/CGA Approved.



FG-LPQDK
LP quick disconnect kit - includes 12' (144") 1/2" OD, 3/8" ID, gray PVC hose with quick disconnect fitting.



FG-LPRK
100K BTU Liquid Propane Regulator, 3/8" MPT Adapter and Acme Quick Connect. CSA-AGA/CGA approved.



FIRE FEATURE ACCESSORIES



REPLACEMENT

Replacement Parts & Kits

FG-AWS-SVC-KIT

FG-TP : Thermopile - for primary pilot assembly
FG-HSI : Hot Surface Ignition - for pilot burner assembly
FG-AWS-CONTROLLER : Main Controller Module

FG-TMSI-PILOT-SVC-KIT

FG-IGNIT-ASSY-PI: Igniter Assembly
FG-SPARK-IGN: Spark Igniter Assembly
FG-GASVALVE-2: Gas Valve (piloted)
FG-CONTROL-KNOB: Control Knob

FG-TFS-SVC-KIT

VCS-5000MODTC : Module
AF-4000BP12 : Battery Pack w/12' wire
TFS-IGNT-ASSEMBLY : Igniter Assembly
ST3-100-1027 : Mesh Screen cover for Ignition Hood
ST3-113-1028 : Stainless Thread Cutting Screws (8)

FG-LTFS-SVC-KIT

PILOTO23300-206 : Pilot Assembly
VCS-5000MODTC : Module
AF-4000BP12 : Battery Pack w/12' wire

FG-TMSI-SVC-KIT

TMS-TC-ASSEMBLY : Thermocouple/Rainshield Replacement Kit
ST3-080-1009 : Copreci Manual Gas Valve
ST3-110-1005 : Mounting Nut for Copreci Valve
ST3-050-1024 : Manual Gas Valve Knob for Copreci Valve
3042-RB : Manual Spark Ignitor Module with Red Button
PIEZO23WH : 23" Piezo Extension wire
PIEZO48WH : 48" Piezo Extension wire
ST3-100-1027 : Mesh Screen Cover (for ignition hood)
ST3-113-1028 : Stainless Thread Cutting Screws



PILOTO-23300-206
L series burner pilot assembly



FG-SPARK-IGN
Spark igniter for TMSI LOF systems



FG-CONTROL-KNOB
Control knob for all LOF burners featuring TMSI LOF ignition



VCS-5000MODTC
Ignition module



FG-THERMOCOUPLE
Thermocouple for non-piloted TMSI Line Of Fire systems



ST3-080-1009
Copreci manual gas valve for round, square and flat burners featuring TMSI ignition system



FG-IGNIT-ASSY-PI
Ignition assembly for piloted TMSI Line Of Fire systems



TFS-IGNT-ASSEMBLY
Ignition module, igniter probes, thermocouple and ignition hood



TMSI-TC-ASSEMBLY
Copreci Thermocouple with Ignition hood



FG-GASVALVE-1
Gas valve (non-piloted) for LOF TMSI systems



FG-GASVALVE-2
Gas Valve (piloted) Fits: LOF-48LHTMSI-N, LOF-48LTTMSI-N, LOF-60LTTMSI-N

AWS Ignition Accessories & Replacement Parts



FG-AWS-PS-30V320
30VDC, 320W Power Supply



GOE-30VDC
30 VDC power supply for single fire feature



AWS-SWITCH-KIT
Stainless steel faceplate with switch



AWS-FACEPLATE
Stainless steel faceplate (only)



FG-HEATSHIELD
AWS heat shield



FG-ICB
AWS Ignition control box



FG-TIMER-2HR
Two (2) hour mechanical timer.



FG-1420-AOD
1420-A (On/Off/Remote) with 110 Receiver.



FG-EMER-STOP
Electronic emergency stop for 120VAC or 30 VDC.



FG-FD2HW
120 min mechanical timer (no enclosure)



FG-AWS-PBO-P
Pilot burner orifice for FG-AWS30VDC-GOEK and FG-AWS30VDC-K

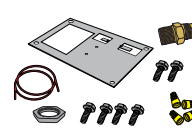

FG-AWS-HARDWARE-BAG
Hardware bag for AWS valve systems



FG-PBA
FG-AWS pilot burner assembly (30" long)



GAS FLEX



GAS FITTINGS

Gas Flex



T200-9898-10
1/2" OD (3/8" ID) x 10", with 1/2" OD FLARE NUTS

T200-9898-16
1/2" OD (3/8" ID) x 16", with 1/2" OD FLARE NUTS

T200-9898-22
1/2" OD (3/8" ID) x 22", with 1/2" OD FLARE NUTS

T200-9898-28
1/2" OD (3/8" ID) x 28", with 1/2" OD FLARE NUTS

T200-9898-34
1/2" OD (3/8" ID) x 34", with 1/2" OD FLARE NUTS

T200-9898-46
1/2" OD (3/8" ID) x 46", with 1/2" OD FLARE NUTS

Gas Fittings



U1-6C-S
Steel Gas Flare Fitting,
3/8" OD Flare x 3/8"
MIP (tapped 1/8" FIP)



U1-6D-S
Steel Gas Flare Fitting,
3/8" OD Flare x 1/2"
MIP (tapped 3/8" FIP)



U1-8C-S
Steel Gas Flare Fitting,
1/2" OD Flare x 3/8"
MIP (tapped 1/4" FIP)



U1-8D-S
Steel Gas Flare Fitting,
1/2" OD Flare x 1/2"
MIP (tapped 3/8" FIP)



U3-6D-S
Steel Gas Flare Fitting,
3/8" OD Flare x 1/2" FIP



U3-8D-S
Steel Gas Flare Fitting,
1/2" OD Flare x 1/2" FIP

Custom Fire Features



Not all projects fit within our product line. But don't worry. We've got you covered. Visit our website or scan the QR code to fill out the Custom Order Form. An associate will reach out to you if we have any questions regarding your form submission.

Quote Turn-Around Time: 3-4 Business Days

Online Resources



Gas Pipe Sizing Chart



How Much Media



Firegear Warranty



Tech & Sales 800.966.8126
firegearoutdoors.com